

*** ALWAYS RANGE TEST THE UNIT ON SITE BEFORE INSTALLATION ***

Mounting the Intercom

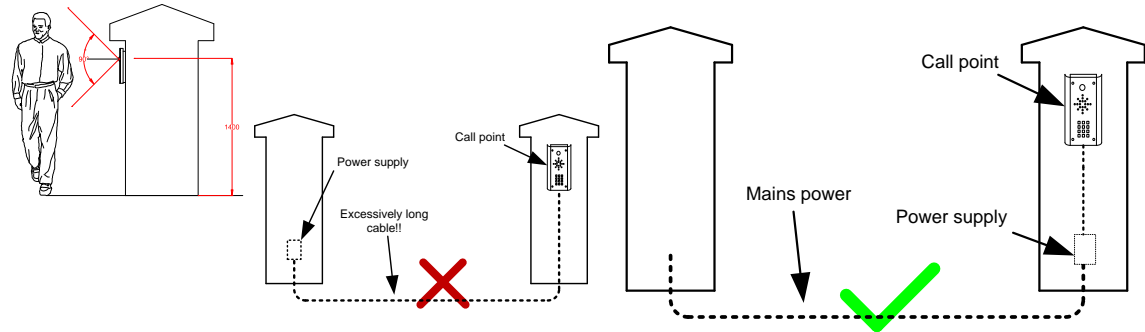

Mount the intercom at the desired height for pedestrian or car users. The camera angle is wide at 90 degrees to cover most scenarios.

Tip: Do not drill holes in the wall with the intercom in position, otherwise dust may get around the camera window and impair the camera view.

Mounting the Transmitter

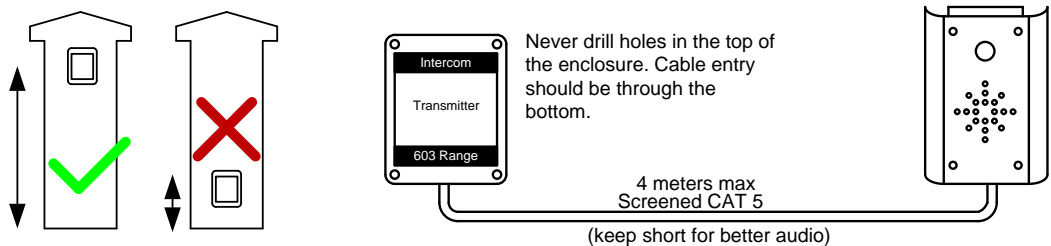

Tip: The transmitter should be mounted as high as possible on the gate pillar or wall to maximise range. Mounting close to the ground will reduce range and is also more likely to be further restricted by long wet grass, overhanging shrubs and vehicles.

LIGHTNING PRONE AREAS MUST USE SURGE PROTECTION FOR POWER SUPPLY!

See overleaf for more PCB details
Turn Over

SITE SURVEY

RESTOCKING FEES MAY APPLY IF RETURNED AFTER INSTALL DUE TO SITE ISSUES. PLEASE SEE FULL T&C'S ON OUR WEBSITE.

TIP: You must test to ensure that the system is capable of operating across the desired range. Power the system on and place the handsets in their expected locations around the property to ensure that the system is fully functional and suitable for the site.



Please read this entire manual before installing this product. A full comprehensive manual is available on our website for additional information.



Set up on a bench in workshop **BEFORE** going to site. Program the unit in the comfort of your work bench and call technical support should you have any questions.

POWER CABLE

KEEP POWER SUPPLY AS CLOSE AS POSSIBLE.

TIP: Most technical calls received are due to installers using CAT5 or alarm cable to power the unit.

NEITHER are rated to carry enough power! (**1.2amp peak**)

Please use the following cable:

- Up to 2 metres (6 feet) – Use minimum **0.5mm²** (**18 gauge**)
- Up to 4 metres (12 feet) – Use minimum **0.75mm²** (**16 gauge**)
- Up to 8 metres (24 feet) – Use minimum **1.0mm²** (**14 / 16 gauge**)

INGRESS PROTECTION



We recommend sealing all entry holes for prevention of insects that can cause issues with a risk of shorting out components.



To maintain the IP55 rating please follow the sealing instructions included. (also available online)



NEED MORE ASSISTANCE?
+44 (0)288 639 0693

SCAN THIS QR CODE TO BE BROUGHT TO OUR RESOURCES PAGE.
VIDEOS | HOW-TO GUIDES | MANUALS | QUICK START GUIDES

EXTRA RESOURCES

*** ALWAYS RANGE TEST THE UNIT ON SITE BEFORE INSTALLATION ***

Handsets

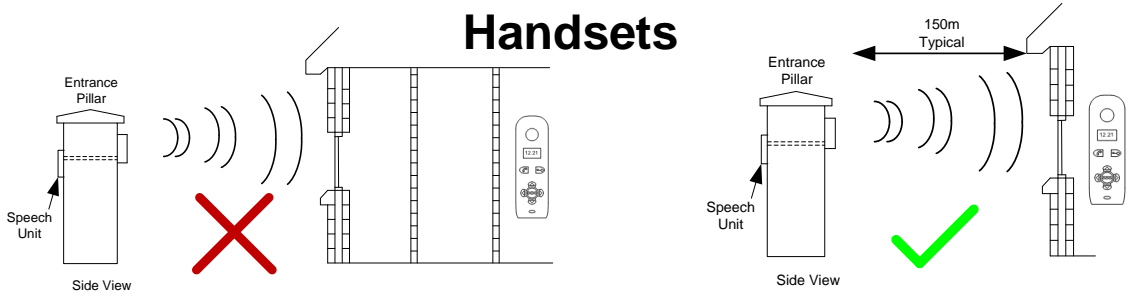

Tip: For longer range installations, locate the handset close to the front of the property, near a window if possible. Concrete walls can reduce the open-air range of 450 meters by 30-50% per wall.

Tip: To achieve best range, locate the handset away from other sources of radio transmission, including other cordless phones, wifi routers, wifi repeaters, and laptops or PCs.

703 Handsfree (Wall Mount) Receiver

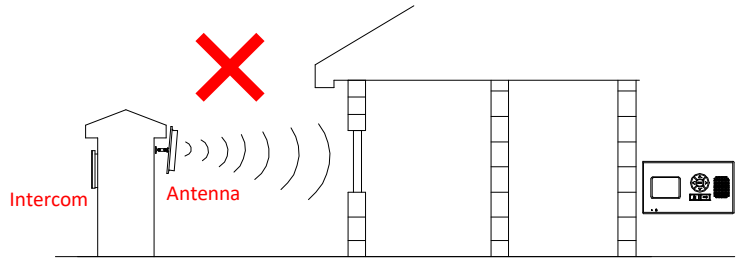

Tip: The 603 HF unit has a built-in antenna/receiver, it is best to use this for short range installs. For longer range installs, fit an external antenna

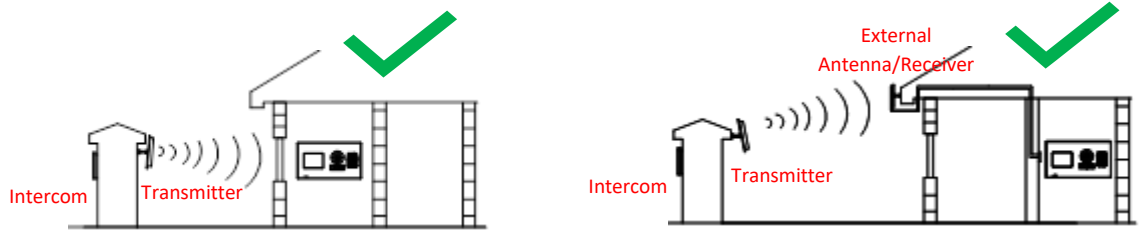

External antenna / receiver can be purchased separately from your local distributor.

OPTIMAL RANGE

SYSTEM INCOMPATIBLE WITH FOIL INSULATION.

TIP: For longer range installations, locate the handset closest to the front of the property and near a window if possible. Also ensure the antenna is mounted pointing towards the handset. Concrete walls can reduce the normal open-air range of up to 450 meters by **30-50% per wall.**

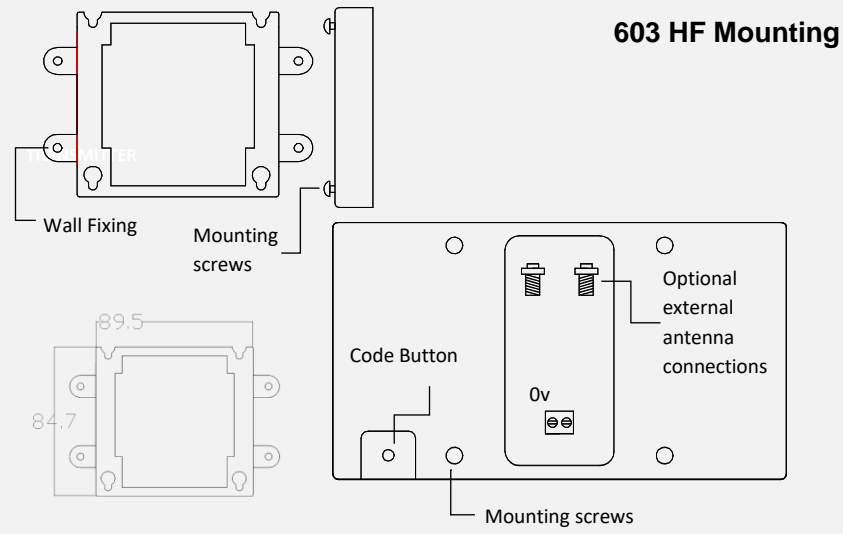

External DECT Antenna

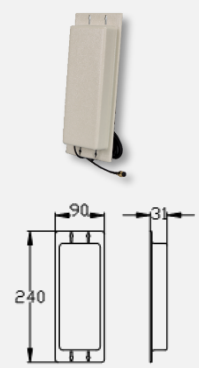

Portable Audio Handset

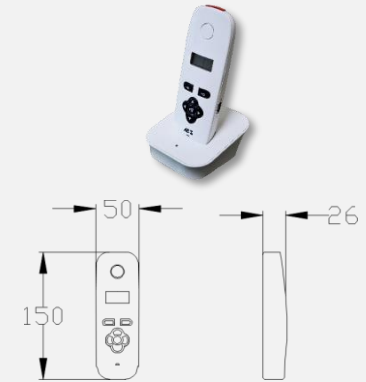

Wall Mounted Audio Panel

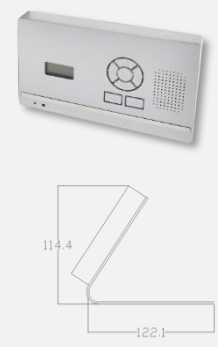

* ALWAYS RANGE TEST THE UNIT ON SITE BEFORE INSTALLATION *

WIRING DIAGRAM

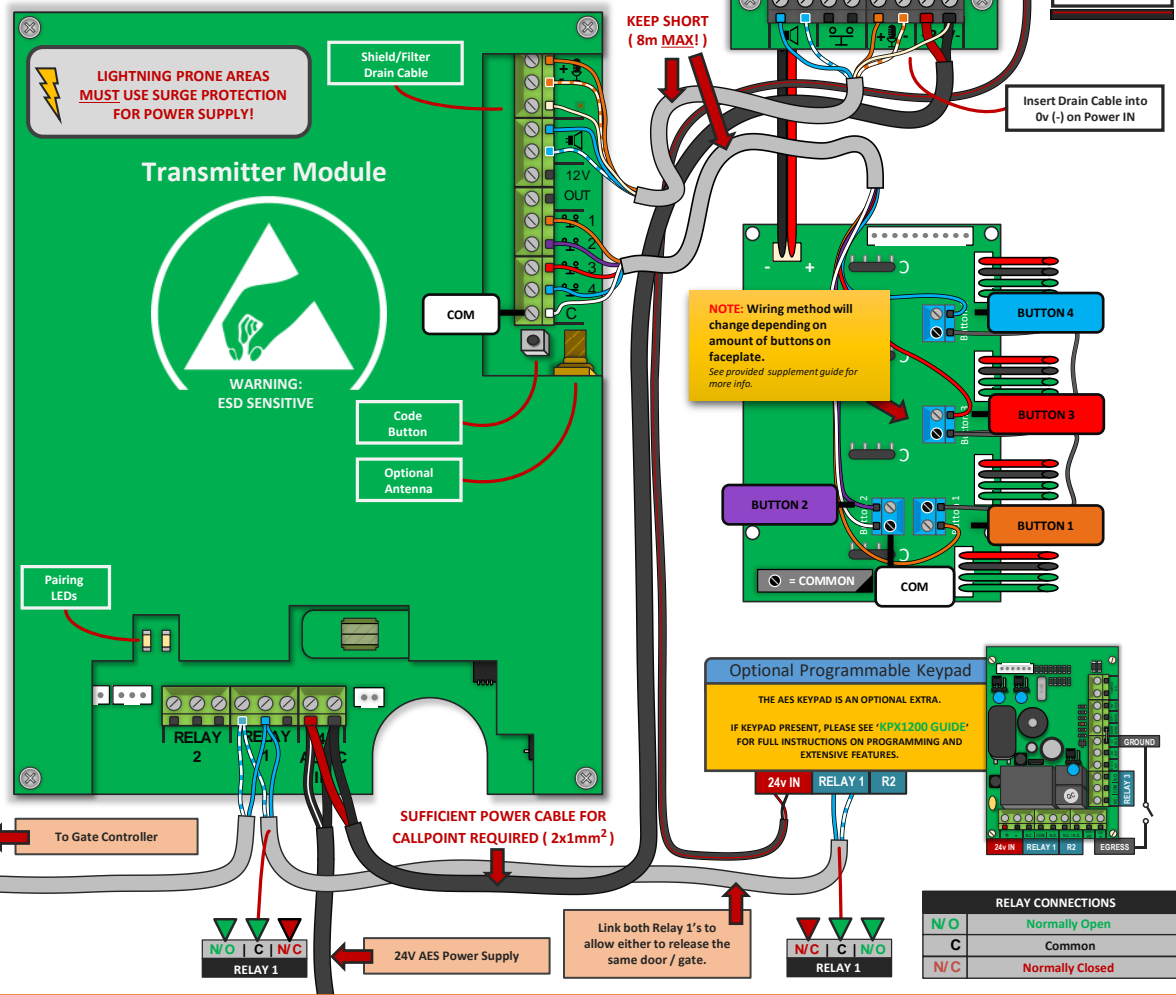

POWER CABLE

KEEP POWER SUPPLY AS CLOSE AS POSSIBLE.

TIP: Most technical calls received are due to installers using CAT5 or alarm cable to power the unit.
NEITHER are rated to carry enough power! (1.2amp peak)
Please use the following cable:

- Up to 2 metres (6 feet) – Use minimum 0.5mm² (18 gauge)
- Up to 4 metres (12 feet) – Use minimum 0.75mm² (16 gauge)
- Up to 8 metres (24 feet) – Use minimum 1.0mm² (14 / 16 gauge)

DID YOU KNOW?

We also have GSM (Global system for mobile) multi apartment intercom available.
2-4 buttons panels available. Each button calls a different mobile. Easy to talk to visitors and operate door/gates by phone.



MAGNETIC LOCK EXAMPLE

Follow this method when using a magnetic lock. If the relay in either the Transmitter or optional AES Keypad is triggered it will temporarily lose power and allow the door/gate to release.
For installs without the optional AES Keypad; connect the POSITIVE of the Magnetic Lock PSU to N/C terminal on Transmitter Relay.

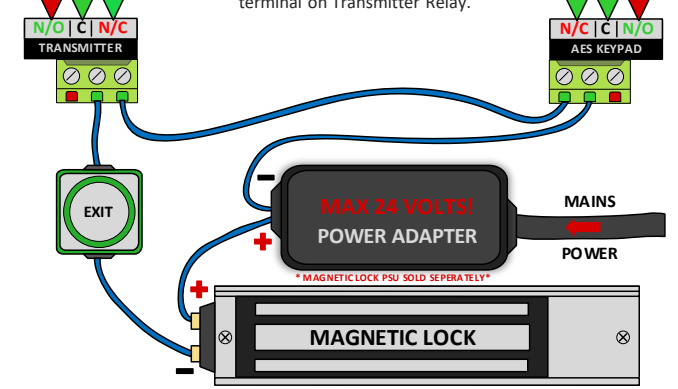

Did you know?

With our 703 DECT audio system you can add up to a max of 4 portable handsets or wall mounted versions.
(1 DEVICE WILL RING PER BUTTON)



NEED MORE ASSISTANCE?

Please scan this QR Code to be brought to our Resources page where you can find all of our guides and available resources.



EXTRA RESOURCES

*** ALWAYS RANGE TEST THE UNIT ON SITE BEFORE INSTALLATION ***

INFORMATION ABOUT YOUR DECT HANDSET

The handset should ideally be charged for at least 8 hours before use. It is recommended to give it at least 60 minutes of charge before performing the range test between the transmitter module and the handset inside.

Adjusting the Relay trigger time

Press and hold the RELAY 2 button for 3 seconds, scroll through the menu until you see 'ti'. Press the OK button to select the relay time. Press the right arrow key at any time to end the process.

Adjusting the time on your handset

Press and hold the OK button for 3 seconds, then use the up and down keys to select the hour and press OK button again to cycle to minutes. Once you have finished adjusting the time then press the OK button to save. Press the right arrow key at any time to end the process.

Voicemail On/Off

You can turn the voicemail function of the system On/Off at any time. To start press and hold the RELAY 2 button for 3 seconds then scroll through the menu until you see 'Re' and adjust this to ON or OFF then press OK to select.

To listen to a voicemail, press OK. If there is more than 1 use up and down to select the message required and press OK to play. Press RELAY 1 once to delete the message or press and hold it to delete all.

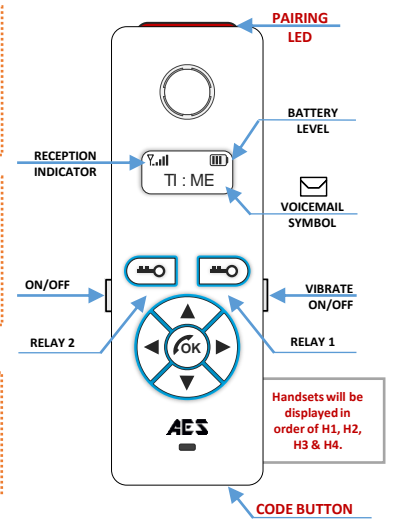

RE-CODING/ADDING EXTRA HANDSETS

Occasionally the system may need to be re-coded once installed. If the handset does not ring when the call button is pressed, the system may need to be re-coded.

- (● = FULL RE-CODE : STEP 1-5)
- (● = ADDING A HANDSET : STEP 3-5)



- **Step 1**) Press and hold the **CODE BUTTON** inside the Transmitter Module for 5 seconds until the audible tone is heard from the Intercom speaker.
(On 703 Transmitter the blue LED marked D17 should also flash.)
- **Step 2**) Then press the **CODE BUTTON 14 times** and wait until the melody is heard or the LED turns off. Performing this step will remove **ALL** handsets currently synced (or partially synced) to the system.
(Note: Doing this step will also clear ALL voicemails after reset.)
- **Step 3**) Press and hold the **CODE BUTTON** inside the Transmitter Module for 5 seconds until the blue pairing LED marked as **D17** begins to flash.
(An audible tone will be heard from the Intercom Speaker.)
- **Step 4**) Then press and hold the **CODE BUTTON** on the handset until the red LED at the top begins to flash. After a few seconds you will hear a melody play to let you know it has successfully connected.
(Repeat Steps 3 & 4 for each new handset.)
- **Step 5**) Finally you should test the kit to ensure that everything is working as expected by pressing the Call Button on the CallPoint to ensure the handset and/or wall mounted unit receives the call and that the two way speech is functioning correctly.

AC/DC STRIKE LOCK WIRING EXAMPLE

Follow this method when using a Strike Lock with the system. If used it will mean that if a relay in either the Transmitter or optional AES Keypad is triggered it will temporarily allow the door/gate to release.

Do you require a custom wiring diagram for your site? Please send all requests to diagrams@aesglobalonline.com and we will do our best to provide you with a supplement diagram suitable for your chosen equipment.

We are constantly using your customer feedback to enhance all of our guides / learning material for installers. If you have any suggestions regarding this please send any suggestions to feedback@aesglobalonline.com

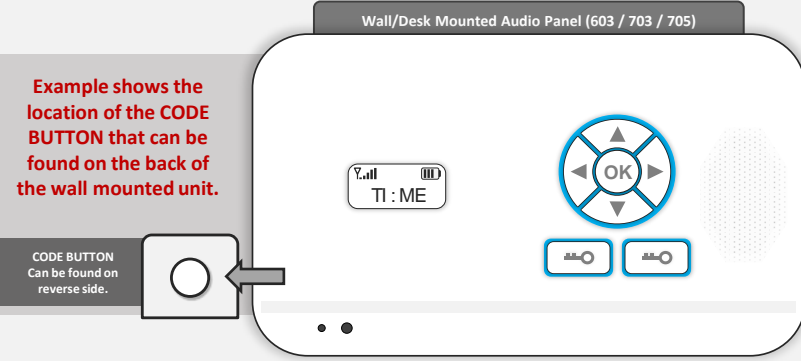
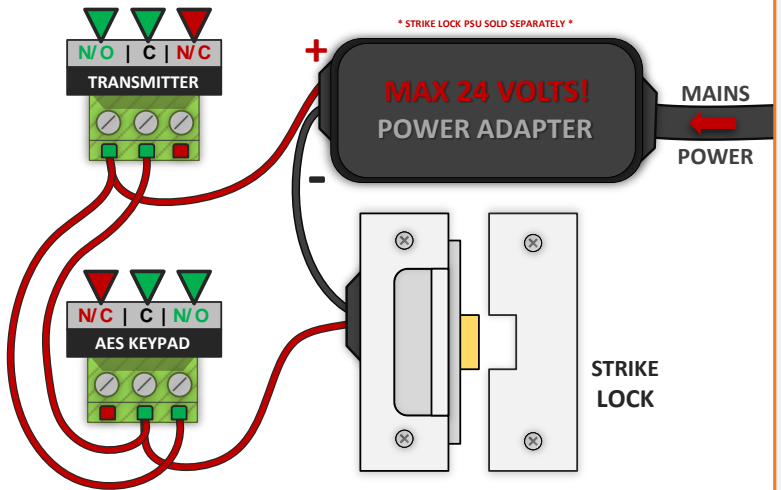

* ALWAYS RANGE TEST THE UNIT ON SITE BEFORE INSTALLATION *

AES KPX1200 STANDARD OPERATIONS

- 1** (LEDs ABOVE KEYPAD FRONT)
- 2**
- 3**

LED 1 = RED/GREEN. It lights up in **RED** while one of the outputs is inhibited. It is flashing during inhibition paused. It is also the **Wiegand** LED for feedback indication and will light up in **GREEN**.
LED 2 = AMBER. It flashes in Standby. It shows the system status in synchronization with the beeps.
LED 3 = RED/GREEN. It lights up in **GREEN** for **OUTPUT 1** activation; and **RED** for **OUTPUT 2** activation.

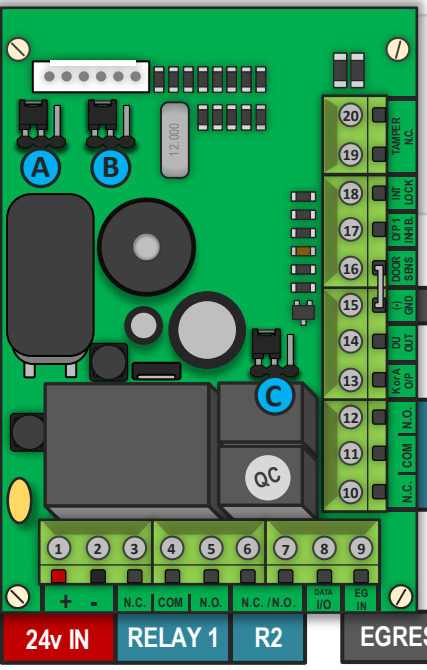

{A} BACK-LIT JUMPER = FULL/AUTO.
FULL – The keypad gives dim backlit in standby. It turns to full backlit when a button is pressed, then back to dim backlit 10 secs after the last button is pressed.
AUTO – The backlit is **OFF** in standby. It turns to **FULL** backlit when a button is pressed, then back to **OFF** 10 seconds after the last button is pressed.

{B} ALARM OUTPUT SETTING = (RESOURCES PAGE - ADVANCED WIRING OPTIONS)

{9,15} Egress for PTE (Push To Exit)
 If you wish to make use of this feature you must wire your PTE switch using terminals 9 & 15 marked as 'EG IN' and '(-) GND'.
Note: The egress feature on the keypad is designed to only activate **Output 1**. Ensure that the entry you wish to gain access to via the PTE switch is connected to this output. Programmable for Instant, Delay with Warning and/or Alarm Momentary or Holding Contact for Exit Delay.

AES KPX1200 RELAY OUTPUT INFORMATION

- {3,4,5} RELAY 1 = 5A/24VDC Max. N.C. & N.O. dry contacts. 1,000 (Codes) + 50 Dussess Codes**
- {6,7,C} RELAY 2 = 1A/24VDC Max. N.C. & N.O. dry contacts. 100 (Codes) + 10 Dussess Codes (COMMON port is determined by the Shunt Jumper marked as C on the diagram. Connect your device to N.C. and N.O. and then move the jumper to the required position and test.)**
- {10,11,12} RELAY 3 = 1A/24VDC Max. N.C. & N.O. dry contacts. 100 (Codes) + 10 Dussess Codes**
- {19,20} Tamper Switch = 50mA/24VDC Max. N.C. dry contact.**

RELAY CONNECTIONS	
N/O	Normally Open
C	Common
N/C	Normally Closed

ALL THREE OUTPUTS ARE VOLT-FREE CONTACTS.

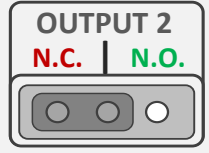

^MOVE JUMPER LINK^

{1,2} 24v 2Amp = Regulated PSU
 (Pre-wired for inside an AES Intercom System)

Did you know?

Extra Prox cards and Prox Tags can be purchased in packs of 10 & 50.
 (PROX versions only)



NEED MORE ASSISTANCE?

Please scan this QR Code to be brought to our Resources page where you can find all of our guides and available resources.



EXTRA RESOURCES

SITE SURVEY

TIP: If fitting this keypad as an independent system then no site survey is required. If the keypad is included inside a callpoint then please follow the site survey details included on the main product guide.

POWER CABLE

KEEP POWER SUPPLY AS CLOSE AS POSSIBLE.

TIP: Most technical calls received are due to installers using CAT5 or alarm cable to power the unit.

NEITHER are rated to carry enough power! (**1.2amp peak**)

Please use the following cable:

- Up to 2 metres (6 feet) – Use minimum **0.5mm² (18 gauge)**
- Up to 4 metres (12 feet) – Use minimum **0.75mm² (16 gauge)**
- Up to 8 metres (24 feet) – Use minimum **1.0mm² (14 / 16 gauge)**

STRIKE LOCK WIRING METHOD

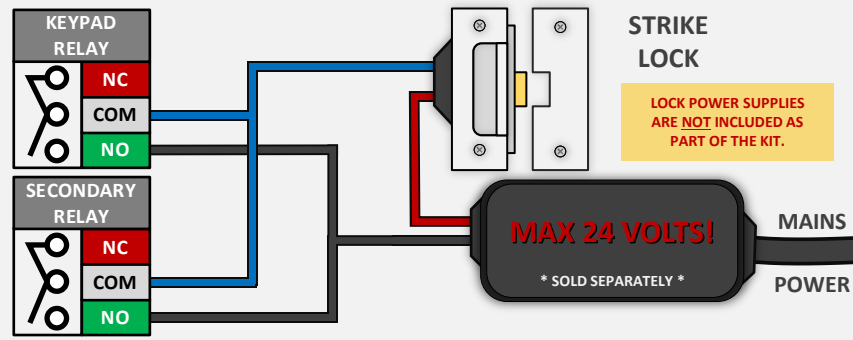

MAGNETIC LOCK WIRING METHOD

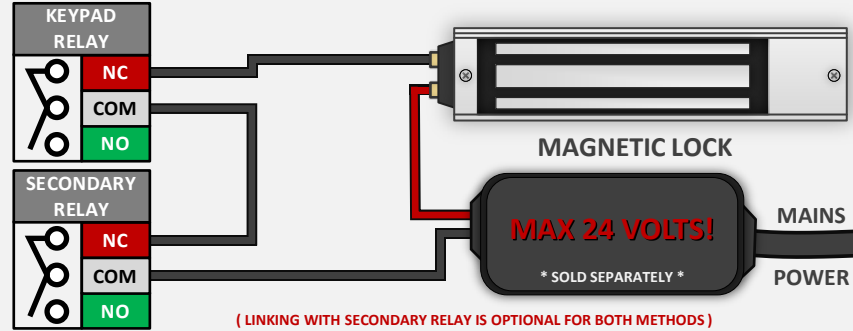

*** ALWAYS RANGE TEST THE UNIT ON SITE BEFORE INSTALLATION ***

KEYPAD PROGRAMMING

Note: Programming can only begin 60 seconds after powering the device on. *** UNLESS OVERRIDDEN ***

1) Enter programming mode:

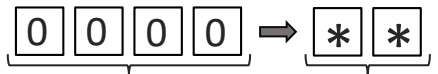

DEFAULT PROGRAMMING CODE ENTER / EXIT PROGRAMMING

The amber LED will remain **SOLID** once you enter programming mode successfully. Press ** again to leave programming mode.

2) Adding and deleting a new keypad entry code:

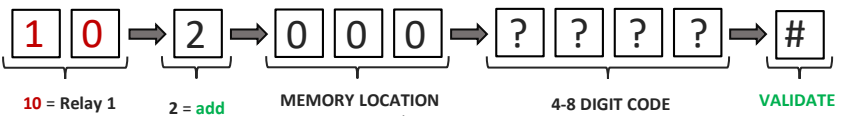

10 = Relay 1 (1000 limit)
20 = Relay 2 (100 limit)
30 = Relay 3 (100 limit)

2 = add
5 = delete

MEMORY LOCATION
000 to 999 = Relay 1
001 to 100 = Relay 2
001 to 100 = Relay 3

Note: After using '5' to delete a code just type the memory location followed by #

** This example will add code '????' to location 000 on Relay 1 **

3) Delete ALL of the codes & cards saved in a relay group:



10 = Relay 1 (1000 limit)
20 = Relay 2 (100 limit)
30 = Relay 3 (100 limit)

SUPER DELETE CODE VALIDATE

Note: Take care when deleting full relay groups because once deleted there is no way to restore these previously stored codes to the keypad.

** This example will delete ALL of the codes stored for Relay 1 **

4) Change relay output times & modes:



51 = Relay 1
52 = Relay 2
53 = Relay 3

0 = LATCHING MODE
1-99999 = MOMENTARY TRIGGER TIME (SECONDS)

Note: Setting the relay time to 0 will change all codes for this output to latching codes, re-enter same code again to unlatch.

** For example: '515#' will set Relay 1 to trigger for 5 seconds **

KEYPAD PROGRAMMING CONTINUED

5) Adding a SUPER user code: (1 MAX)

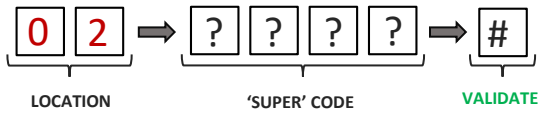

LOCATION 'SUPER' CODE VALIDATE

Note: You can add one SUPER code as an optional feature which allows a single code to operate all 3 outputs. To use input SUPER code followed by # then 1, 2 or 3 to select.
Example - 5555#2

6) Change the programming code:

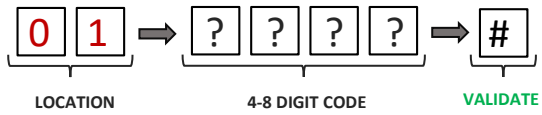

LOCATION 4-8 DIGIT CODE VALIDATE

Note: If you set a 4-8 digit code then user codes must also be the same amount of digits.

Example: If you set a 6 digit programming code all access codes must also be 6 digits long.

*** ALWAYS MAKE NOTE OF NEW CODE ONCE CHANGED ***

(OPTIONAL PROGRAMMING FOR PROX MODELS ONLY)

7) Adding a new PROX card or tag:



10 = Relay 1 (1000 limit)
20 = Relay 2 (100 limit)
30 = Relay 3 (100 limit)

1 = add

MEMORY LOCATION
000 to 999 = Relay 1
001 to 100 = Relay 2
001 to 100 = Relay 3

PROX CARD
SWIPE PROX CARD or TAG

VALIDATE

** This example will add a PROX card/tag to location 001 on Relay 1 **

8) Deleting a new PROX card or tag:



10 = Relay 1 (1000 limit)
20 = Relay 2 (100 limit)
30 = Relay 3 (100 limit)

5 = delete

MEMORY LOCATION
000 to 999 = Relay 1
001 to 100 = Relay 2
001 to 100 = Relay 3

VALIDATE

Note: Keep in mind that keypad codes and PROX card/tags must be saved in their own separate memory locations.

If a keypad code is stored on location 035 this means a card cannot be added to location 035.

** This example will delete a PROX card/tag from location 001 on Relay 1 **

PROGRAMMING CODE NOT WORKING?

Note: In the event that the programming code has been forgotten or changed by accident, a **DAP Reset** of the keypad can be performed during the **60 second bootup phase**. Pressing the PTE during this time or replicating this by shorting terminals 9 & 15 together with a jumper link the keypad will emit 2 short beeps if this step has been performed successfully. Then enter the **DAP Code** (Directly Access Programming Code) (**8080****) on the front of the keypad as a backdoor into programming mode which will allow you to now set a new programming code, as per **Step 6** above.

* ALWAYS RANGE TEST THE UNIT ON SITE BEFORE INSTALLATION *

Configuration for Latching via the handset (keypad models only)

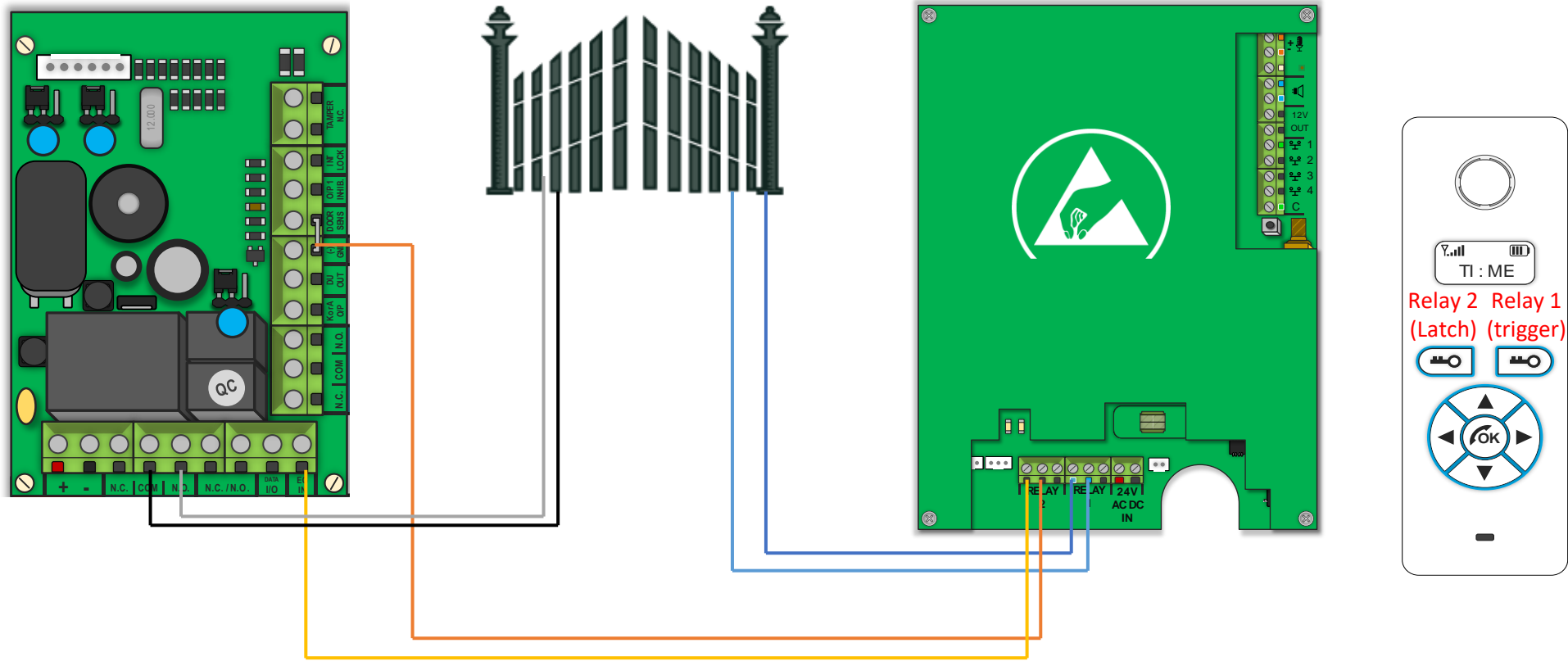

Relay 1 on the Keypad will have to be switched to a latching Relay see Keypad Programming Guide for Further instructions:
If you are still looking the keypad to trigger the gates you will have to use relay 2 or 3 and program accordingly.
Relay 1 on the transmitter will still trigger the gates but relay 2 will latch the gates from the transmitter

* ALWAYS RANGE TEST THE UNIT ON SITE BEFORE INSTALLATION *

Portable Audio Handset

Call Another Handset

Press **▶** and the unit will display 'HS1', 'HS2', 'HS3', 'HS4' depending on how many handsets are coded in the system. Then use the **◀** and **▶** you can select the handset you wish to call and then press **OK** to start the call.

Change Ring Volume

Press **▲** and **▼** to increase or decrease the ring volume and then press **OK** to save.

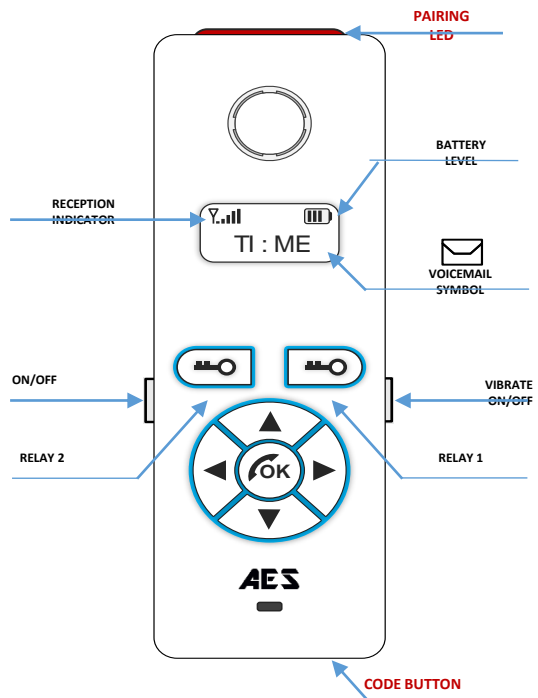

Handsets will be displayed in order of H1, H2, H3 & H4. (only 1 handset per button)

HANDSET BATTERIES INCLUDED (2 x AAA 600mA Rechargeable)

Voicemail

When a call is not answered within 40 seconds, the visitor can leave a message. Once complete, the handset will display the symbol. The unit can store up to 16 voice messages.

Change Ring Tone

Press **◀** and the handset will ring with its currently selected tone. Then you can press the **▲** and **▼** keys to cycle through the available ring tones. Then press **OK** to select and save the tone.

To listen to a voicemail, press **OK**. If there is more than 1 use **▲** and **▼** to select the message required and press **OK** to play. Press **▶** once to Delete the message or **press and hold** to delete all.

RE-CODING/ADDING EXTRA HANDSETS

Occasionally the system may need to be re-coded once installed. If the handset does not ring when the call button is pressed, the system may need to be re-coded.

(● = FULL RE-CODE : STEP 1-5)

(● = ADDING A HANDSET : STEP 3-5)



● **Step 1**) Press and hold the **CODE BUTTON** inside the Transmitter Module for 5 seconds until the audible tone is heard from the Intercom speaker.

(On 603 Transmitter the blue LED marked D17 should also flash.)

● **Step 2**) Then press the **CODE BUTTON 14 times** and wait until the melody is heard or the LED turns off. Performing this step will remove **ALL** handsets currently synced (or partially synced) to the system.

(Note: Doing this step will also clear ALL voicemails after reset.)

● ● **Step 3**) Press and hold the **CODE BUTTON** inside the Transmitter Module for 5 seconds until the audible tone is heard from the Intercom speaker.

(On 603 Transmitter the blue LED marked D17 should also flash.)

● ● **Step 4**) Then **press and hold** the **CODE BUTTON** on the handset until the red LED at the top begins to flash, after a few seconds you will hear a melody play to let you know it has successfully connected.

(Repeat Steps 3 & 4 for each new handset.)

● ● **Step 5**) Finally you should test the kit to ensure that everything is working as expected by pressing the Call Button on the CallPoint to ensure the handset and/or wall mounted unit receives the call and that the two way speech is functioning correctly.

Wall/Desk Mounted Audio Panel (603 / 703 / 705)

Example shows the location of the **CODE BUTTON** that can be found on the back of the wall mounted unit.

CODE BUTTON
Can be found on reverse side.

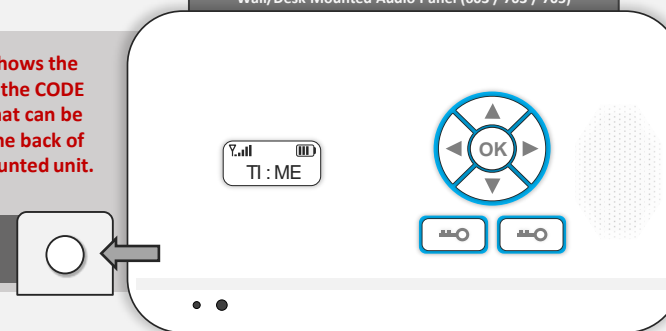



KEYPAD CODE LIST TEMPLATE

PROX ID LIST TEMPLATE

CLIENT NAME	MEMORY LOCATION	KEYPAD CODE	RELAY USED (CIRCLE)
James	000	1234	1 - 2 - 3
Mary	001	4321	1 - 2 - 3
			1 - 2 - 3
			1 - 2 - 3
			1 - 2 - 3
			1 - 2 - 3
			1 - 2 - 3
			1 - 2 - 3
			1 - 2 - 3
			1 - 2 - 3
			1 - 2 - 3
			1 - 2 - 3
			1 - 2 - 3
			1 - 2 - 3
			1 - 2 - 3
			1 - 2 - 3
			1 - 2 - 3
			1 - 2 - 3
			1 - 2 - 3
			1 - 2 - 3

CLIENT NAME	MEMORY LOCATION	PROX ID	RELAY USED (CIRCLE)
James	005	0001548796	1 - 2 - 3
Mary	006	0001589678	1 - 2 - 3
			1 - 2 - 3
			1 - 2 - 3
			1 - 2 - 3
			1 - 2 - 3
			1 - 2 - 3
			1 - 2 - 3
			1 - 2 - 3
			1 - 2 - 3
			1 - 2 - 3
			1 - 2 - 3
			1 - 2 - 3
			1 - 2 - 3
			1 - 2 - 3
			1 - 2 - 3
			1 - 2 - 3
			1 - 2 - 3
			1 - 2 - 3
			1 - 2 - 3

USE THIS AS A TEMPLATE OF HOW TO KEEP TRACK OF ALL OF THE KEYPAD CODES SAVED WITHIN THE KEYPAD. FOLLOW THE FORMAT FROM THE EXAMPLES SET AND IF MORE TEMPLATES ARE REQUIRED THEY CAN BE FOUND ON OUR WEBSITE OR FOLLOW THE QR CODE PROVIDED.



*** ALWAYS RANGE TEST THE UNIT ON SITE BEFORE INSTALLATION ***

TROUBLESHOOTING

Q. The unit will not ring the handset.

- A. Try re-coding the handset and transmitter as per instructions.
- Check push button wiring to the transmitter with multi-meter.
- Check power cable distance from power adaptor to transmitter is less than 4 meters.

Q. The person on the handset can hear interference on the call.

- A. Check cable distance between the speech unit and transmitter. Shorten this if possible.
- Check cable used between the speech unit and transmitter is screened CAT5.
- Check that the screen of the CAT5 is connected to ground in the transmitter as per wiring instructions.

Q. Keypad code not operating the gate or door

- A. Check if the corresponding relay indicator light comes on. If it does, then the fault is either a power problem with excessive cable run, or wiring. If the relay can be heard clicking, then it is a wiring problem. If a click cannot be heard, then it is likely a power problem. If the light does not activate and the keypad emits an error tone, then the issue is likely a programming error.

Q. My handset will not recode

- Try the process again. If it still does not work, delete the code from the transmitter. To delete code, press the code button for 3 seconds and release. Then press it 7 times after which a tone should be heard. Then press another 7 times. Now try re-coding the handset again as per the procedure.

Q. Range problem – Handset works beside the intercom, but not from inside the building

- A. Check that the power cable to the transmitter is within guidelines and is heavy enough gauge. Insufficient power cabling will reduce transmission power! Check that there are not excessive objects blocking the signal, like large dense shrubs, vehicles, foil lined wall insulation etc. Try to achieve line of sight between both devices.

Q. No speech in either direction

- A. Check CAT5 wiring between speech panel and transmitter. Disconnect, re-strip cables and re-connect again.

Q. Handset will not charge

- A. Try replacing both batteries with equivalent Ni-Mh batteries firstly. It is possible to have a dead cell in a battery which can prevent both batteries from charging.
- Check for contamination or grease on the charging pins at the base of the handset (gently scratch with screwdriver or wire wool).

This product is not a complete product until fully installed. It is therefore considered a component part of an overall system. The installer is responsible to check that the end installation complies with local regulatory requirements. This equipment forms part of a "fixed installation".

Note: The manufacturer cannot legally offer technical support to non-qualified gate or door installers. End users should employ the services of a professional install company to commission or support this product!

INTERCOM MAINTENANCE

Bug ingress is a common issue in unit failures. Ensure that all components are sealed accordingly and check occasionally. **(Do not open the panel in the rain / snow unless correctly equipped to keep the internals dry. Ensure the unit is securely closed after maintenance)**

Ensure that the transmitter box (603/703) or antenna (705) do not get blocked by trees, shrubs or other obstacles overtime as this may disrupt the signal to the handsets.

If you have an AB, AS, ABK, ASK callpoint it will have silver edges which are marine grade stainless steel so in normal weather conditions should not rust however it can dull or dis-colour over time. This can be polished with a suitable stainless-steel cleaner and cloth.

ENVIRONMENTAL INFORMATION

The equipment that you bought has required the extraction and use of natural resources for its production. It may contain hazardous substances for the health and the environment. In order to avoid the dissemination of those substances in our environment and to diminish the pressure on the natural resources, we encourage you to use the appropriate take-back systems. Those systems will reuse or recycle most of the materials of your end life equipment.

The crossed-bin symbol marked in your device invites you to use those systems.



If you need more information on the collection, reuse and recycling systems, please contact your local or regional waste administration. You can also contact AES Global Ltd for more information on the environmental performances of our products.

EU-RED Declaration of Conformity

Manufacturer: Advanced Electronic Solutions Global Ltd
Address: Unit 4C, Kilcronagh Business Park, Cookstown, Co Tyrone, BT809HJ, United Kingdom

We/I declare, that the following equipment (DECT intercom), part numbers: 603-EH, 603-TX Multiple Models: 603-AB, 603-ABK, 603-AB-AU, 603-ABK-AU, 603-ABP, 603-AS, 603-AS-AU, 603-ASK, 603-ASK-AU, 603-BE, 603-BE-AU, 603-BEK, 603-BEK-AU, 603-EDF, 603-EDG, 603-HB, 603-NB-AU, 603-HBK, 603-HBK-AU, 603-HS, 603-HSAU, 603-HSK, 603-HSK-AU, 603-IB, 603-IBK, 603-IBK-AU, 603-IBK-BFT-US, 603-IB-BFT-US, 703-HS2, 703-HS2-AU, 703-HS3, 703-HS3-AU, 703-HS4, 703-HS4-AU, 703-HSK2, 703-HSK2-AU, 703-HSK3, 703-HSK3-AU, 703-HSK4, 703-HSK4-AU

Complies with the following essential requirements:

ETSI EN 301 489-1 V2.2.0 (2017-03)
ETSI EN 301 489-6 V2.2.0 (2017-03)
ETSI EN 301 406 V2.2.2 (2016-09)
EN 62311:2008

EN 62479:2010
EN 60065

Australia / New Zealand Approvals:
AZ/NZS CISPR 32 :2015

This declaration is issued under the sole responsibility of the manufacturer.

Signed by: Paul Creighton, Managing Director.
Date: 4th Dec 2018

